



RESEARCH ON THE RELATIVE COORDINATE TRANSFORMATION AND RELATIVE POSITION DETECTION SYSTEM OF 3-DOF SPHERICAL ACTUATOR

Yuanjie Fang*, Bing Xu, Chunhu Sun

College of Mechanical and Electrical Engineering

Chaohu University, Hefei, China

Emails: fangyuanjie@163.com

Submitted: Aug.30, 2016

Accepted: Oct.3, 2016

Published: Dec.1, 2016

Abstract- The attitude detection of 3-DOF actuator is an important technology of 3-DOF spherical actuator control. For the space attitude change of the stator and the traditional detection method is invalid, the relative coordinate transformation is proposed in this paper, through the analysis of the coordinate systems of the spherical actuator. The transformed relative coordinate data is proved by using MATLAB platform. The traditional coordinate transformation and the relative coordinate transformation are compared in this paper. Using the relative coordinate transformation algorithm, the relative position detection system based on the MEMS six-axis sensor is designed. Using two sensors to detect both the attitude of the stator and the rotor, the relative position detection system is realized. The data received from sensor transformed by this method is used to verify the feasibility.

Index terms: Relative Coordinate Transformation; Spherical Actuator; MEMS Six-Axis Sensor; Position Detection System

I. INTRODUCTION

As a multiple degrees of freedom mechanism, spherical actuator can realize more than 1 DOF movement. The mechanical structure can be simplified by using spherical actuator. For the different structure of the of the actuator, the different control algorithm should be designed.[1-7] Single DOF servo motor is studied deeply ,more and more control strategy and control algorithms are proposed[8] and the control theory is been developed vigorously.[9] Since the space scalability of the spherical actuator, the control method should be based on the attitude detection algorithm. Now, the research of the spherical actuator detection algorithm has been developed widely. Hefei University of Technology developed a detection algorithm which using the visual sensor to detect the position of the rotor that the surface is sprayed.[10-11] A passive ball joint is designed as detection mechanism by Beihang university. The inclination angle sensor and optical encoder are built-in the passive ball joint.[12-13]. Since it can only calculate the relative displacement between the rotor and stator, the optical encoder can't determine the attitude of the rotor. The detection method based on inclination angle sensor can achieve the absolute attitude of the rotor, the absolute position detection of the spherical actuator is difficult to apply to the space joint.

The attitude detection system based on the attitude detection sensor is relative to the geodetic coordinate system. Since the geodetic coordinate system is static, the stator of spherical actuator always assumed absolute rest. The spherical actuator's control algorithm should base on the relative position between the stator and rotor. The actuator may be used in space motion to achieve the greater degrees of freedom,. The relative position detection between the stator and rotor is needed, the relative coordinate transformation and detection system is imminent.

II. THE COORDINATE SYSTEMS OF 3-DOF SPHERICAL ACTUATOR

The 3-DOF spherical actuator, same as convention motor, is composed of stator and rotor. Since the convention motor has a fixed output shaft, by contrast, the spherical actuator didn't have a fixed shaft, the rotation axis is virtual that doesn't exist. The output shaft is used to produce torque. The 3-DOF spherical actuator's structure is shown in Fig 1.

When the spherical actuator rotates around the expected axis, the relative position between the rotor and the stator is change. The control algorithm of the 3-DOF spherical actuator will be

influenced by the change of the relative position. Due to the structure of the 3-DOF spherical actuator, the tradition detection method is invalid when the spherical actuator acted in the space. In fact, 3-DOF spherical actuator generally composed of 3 basic coordinate systems, shown as Fig 1, the stator coordinate system R_s , the rotor coordinate system R_r and the geodetic coordinate system R_0 . In the traditional detection method, the stator coordinate system R_s and geodetic coordinate system R_0 are regarded as the same coordinate system.

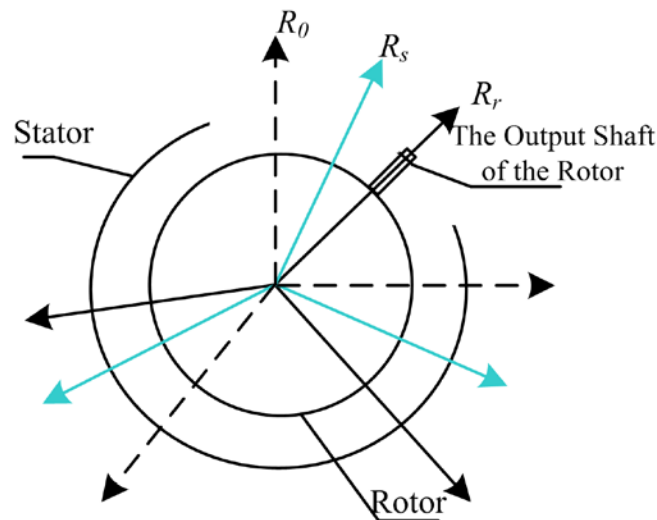

Fig. 1 The coordinate systems of 3-DOF spherical actuator

a. Geodetic Coordinate System R_0

The geodetic coordinate system R_0 is Descartes coordinate system; it's a fixed coordinate system. It meets with right-handed screw rule; consist of three orthogonal coordinate axis X, axis Y, axis Z. The coordinate system is based on the geodetic, setting as reference coordinate system. The direction cosine matrix whose parameter can be direct measured is related to this coordinate system.

b. Stator Coordinate System R_s

The stator coordinate system R_s , attached to the spherical actuator's stator, has 3 quartered axis x_s, y_s, z_s and the center of the stator sphere is set as original point. The axis z_s is pointed to the north of the stator sphere. The stator is static relate to the rotor. Since the stator coordinate system rotates with stator in the space movement, the stator coordinate system is not a static coordinate system.

c. Rotor Coordinate System R_r

The rotor coordinate system R_r , attached to the spherical actuator's rotor, has 3 quartered axis x_r, y_r, z_r and the center of the rotor sphere is set as original point. The axis z_r is pointed to the north of the rotor sphere. The output torque, Lorenz force and space voltage vector should be converted in this coordinate system. Since the rotor coordinate system is rotated with rotor, the rotor coordinate system is a moving coordinate system.

III. SPATIAL COORDINATE TRANSFORM

The coordinate transformation is very important in variable frequency closed loop system for the single axis AC motor. The parametric conversion based on the position detection space coordinate transformation play an important role in the 3 DOF spherical actuator detection systems.

3.1 Traditional Coordinate Transformation

The coordinate transformation is widely used in the strapdown inertial navigation system. The quaternion [14] and the direction cosine matrix methods often adopted in coordinate transformation method. The direction cosine matrix is discussed in this paper.

The relative position between rotor and stator can be determined by a slide frame measuring system. [15] There are 3 optical encoders in the slide frame to detect position signals. The attitude of the rotor can't be detected, and the detection system leading to increasing of the friction. The detection system is shown in the Fig2.

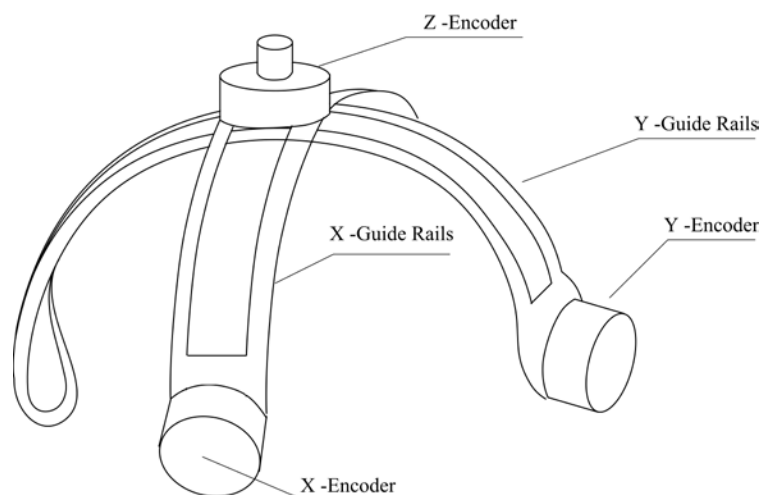

Fig 2 Position Detection System with three Encoder Devices and Slider Holder

The spherical actuator traditional coordinate transformation often contains two detection elements, the attitude of the rotor and the relative position between stator and rotor. The stator coordinate system is assumed fixed in traditional coordinate transformation, and the rotor coordinate system is assumed rotated by Euler angles. In this transformation method, the attitude of the rotor can be determined, but the relative position between rotor and stator is leak measured. A sensor is set to detect the rotor attitude shown in fig 3, and the conversion of coordinates is shown in fig 4. [11] When the stator is rotate in the space, the traditional coordinate transformation is invalid.

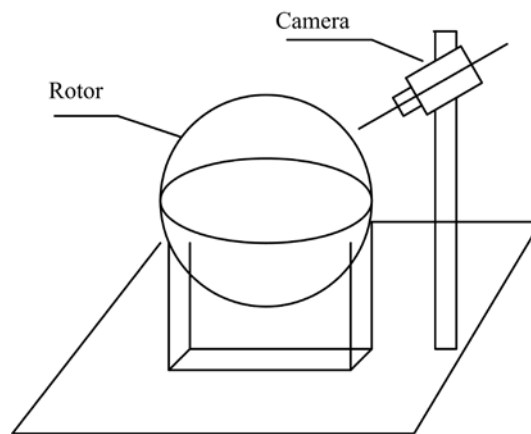

Fig 3 Rotor Orientation Measurement System

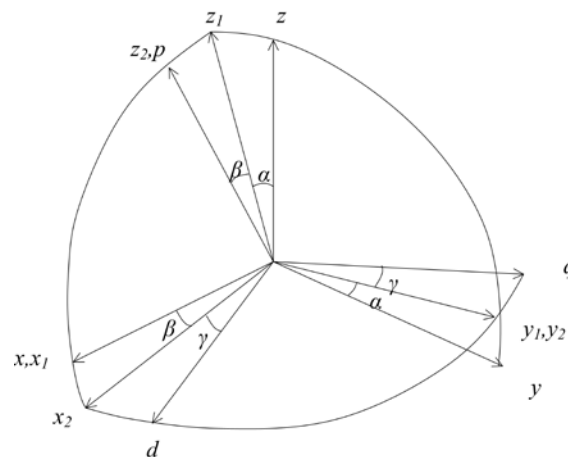

Fig 4 Conversion of Coordinate

There is a coordinate system a in the space, and the coordinate system is rotated around axis X α degrees, rotate around axis Y β degrees, rotate axis Z γ degrees. The coordinate system b is transformed. The rotation of the 3-DOF spherical actuator is shown in the Fig 4. The coordinate transform direction cosine matrix A_a^b from coordinate system a to coordinate system b is shown below.

$$A_a^b = \begin{bmatrix} \cos \beta \cos \gamma & \cos \beta \sin \gamma & -\sin \beta \\ -\cos \alpha \sin \gamma + \sin \alpha \sin \beta \cos \gamma & \cos \alpha \cos \gamma + \sin \alpha \sin \beta \sin \gamma & \sin \alpha \cos \beta \\ \sin \alpha \sin \gamma + \cos \alpha \sin \beta \cos \gamma & -\sin \alpha \cos \gamma + \cos \alpha \sin \beta \sin \gamma & \cos \alpha \cos \beta \end{bmatrix} \quad (1)$$

The transformation matrix can transform the coordinate system xyz to the coordinate dqp shown in the Fig 4.

Assuming a vector $a_0=[x_a, y_a, z_a]^T$ in coordinate system a, it's transformed coordinate in coordinate b is $b_0=[x_b, y_b, z_b]^T$. The transformed new coordinate data should obey the formula below:

$$b_0 = A_a^b a_0 \quad (2)$$

Using direction cosine matrix can achieve any vector coordinate data after rotation. This method is used in the 3 DOF spherical actuator position detection systems. Through measuring the rotated angle, the cosine matrix could be obtained [11].

3.2 Relative Coordinate Transformation

According to the analysis of the coordinate system of the spherical actuator based on the front section, the spherical actuator's coordinate system should include the geodetic coordinate system R_0 , stator coordinate system R_s , rotor coordinate system R_r . When the stator's attitude relate to the geodetic coordinate system have changed, the stator coordinate system will change with it. In this situation, the traditional position detection method is invalid.

The 3-DOF spherical actuator's relative coordinate transformation includes two transformations, the stator-rotor transformation (the transformation of stator coordinate system to rotor coordinate system) and the rotor-stator transformation (the transformation of rotor coordinate system to stator coordinate system). The transformation of stator-rotor could convert physical quantity in stator coordinate system into rotor coordinate system. Relatively the rotor-stator transformation could convert physical quantity in rotor coordinate system into stator coordinate.

3.2.1 Rotor-Stator Coordinate Transformation

Assuming the spherical actuator work in the space, the stator coordinate system R_s is rotated α, β, γ degrees around axis X, Y, Z according the rotation order x-y-z. The angles rotated are the

stator coordinate system relate to the geodetic coordinate system. The two coordinate systems should obey:

$$R_s = A_0^s R_0 \quad (3)$$

Where $A_0^s = R_x(\alpha)R_y(\beta)R_z(\gamma)$ is the direction cosine matrix rotation 3 times, satisfy the formula (1).

The rotor coordinate system R_r is rotated θ, φ, ψ degrees around axis X,Y,Z according the rotation order x-y-z. The angles rotated are the rotor coordinate system relate to the geodetic coordinate system. Two coordinate systems should obey:

$$R_r = A_0^r R_0 \quad (4)$$

Where $A_0^r = R_x(\theta)R_y(\varphi)R_z(\psi)$ is the direction cosine matrix rotation 3 times, A_0^s and A_0^r satisfy the formula (1).

According to the direction cosine matrix's property, the matrix's determinant equals 1. Since $(A_0^s)^{-1}$ is exist, A_0^s is reversible, and it can be solved formula (5).

$$(A_0^s)^{-1} = \begin{bmatrix} \cos \beta \cos \gamma & -\cos \alpha \sin \gamma + \sin \alpha \sin \beta \cos \gamma & \sin \alpha \sin \gamma + \cos \alpha \sin \beta \cos \gamma \\ \cos \beta \sin \gamma & \cos \alpha \cos \gamma + \sin \alpha \sin \beta \sin \gamma & -\sin \alpha \cos \gamma + \cos \alpha \sin \beta \sin \gamma \\ -\sin \beta & \sin \alpha \cos \beta & \cos \alpha \cos \beta \end{bmatrix} \quad (5)$$

And formula (3) can be rewritten in formula (6).

$$R_0 = (A_0^s)^{-1} R_s \quad (6)$$

Take formula(6) into formula(4), it can be achieve formula(7).

$$R_r = (A_0^r (A_0^s)^{-1}) R_s \quad (7)$$

Rewrite $A_s^r = A_0^r (A_0^s)^{-1}$, formula(8) obtained.

$$R_r = A_s^r R_s \quad (8)$$

A_s^r is the relative coordinate transformation matrix .

A_s^r is the stator-rotor relative transformation matrix. According to formula (1), the A_s^r is a special case of the stator rotate the given axis 0° .

Using A_s^r transformation matrix, arbitrary coordinate data in the stator coordinate system can be transformed into rotor coordinate system. Only the rotation angles α, β, γ , which acquired by the stator coordinate system relate to the geodetic coordinate system, and the rotation angles θ, φ, ψ , which acquired by the rotor coordinate system relate to the geodetic coordinate system should be measured to calculate the transformation matrix A_s^r . The relative position detection can be solved by the relative coordinate transformation.

3.2.2 Stator-Rotor Coordinate Transformation

According to $|A_s^r|=1$, the relative transformation matrix is invertible. The following formula will be obtained.

$$R_s = (A_s^r)^{-1} R_r \quad (9)$$

That is, $A_r^s = (A_s^r)^{-1}$

The formula shows the data in the rotor coordinate system can be converted to the stator coordinate system. A_r^s is the coordinate transformation matrix.

The matrix of the stator to rotor coordinate transformation and the matrix of the rotor to stator coordinate transformation are too complicated will not shown in the paper.

3.3 Data Simulation Experiment

3.3.1 Traditional Coordinate Transformation Experiment

The data simulation experiment is taken to test the traditional coordinate transform. Assume a point (0,0,1) on the sphere in the geodetic coordinate system, the rotor coordinate system rotate $1^\circ \sim 20^\circ$ around x axis. The stator coordinate system doesn't rotate and coincide with the geodetic coordinate system. These transformed coordinate data in the stator coordinate system are shown in the Fig 5. These data equals the points in space coordinate rotate $1^\circ \sim 20^\circ$ around the x axis. The traditional detection is based on the algorithm.

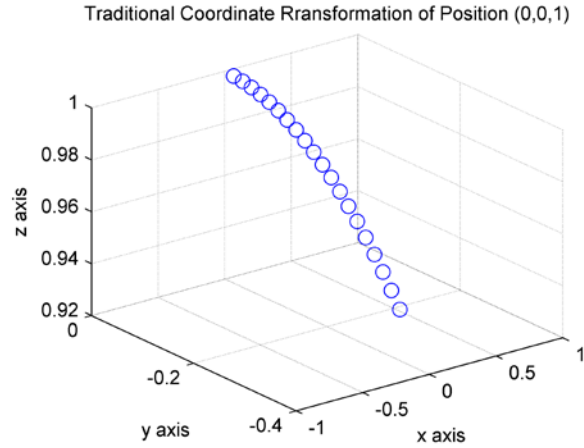

Fig. 5 Traditional Coordinate Transformation Simulation Result

3.3.2 Stator-Rotor Coordinate Transformation Experiment

20 points on the spherical surface of stator are taken, which coordinate data is $(0, \sin 1^\circ, \cos 1^\circ) \sim (0, \sin 20^\circ, \cos 20^\circ)$. Assume the rotor coordinate system rotate 20 degrees around the Y axis, the stator rotate 10 degrees around X axis, rotate 30 degrees around Y axis, rotate 0 degree around Z axis. The coordinate data are converted to rotor coordinate system by using the matrix A_y^r . The converted coordinate and the original coordinate are shown in the same coordinate system. The display result is shown in the Fig 6. The X point in the graph is the point after the transformation of the coordinate system, and the point of the O point is the front of the coordinate transformation.

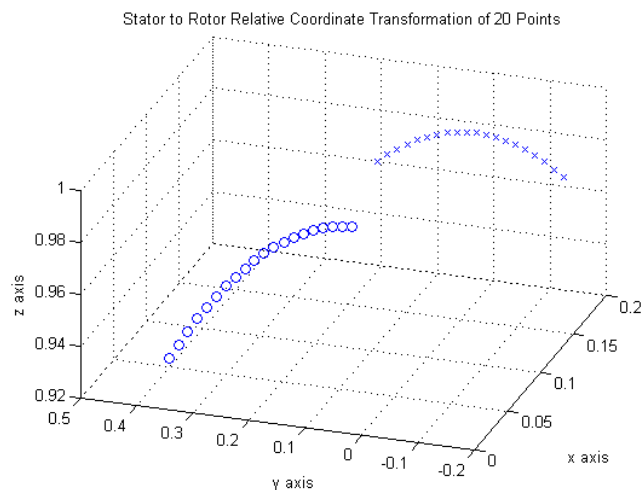

Fig. 6 Stator-Rotor Coordinate Transformation Simulation

3.3.3 Rotor-Stator Coordinate Transformation Experiment

Similarly, 20 points on the spherical surface of the rotor are taken, which coordinate data is $(0, \sin 1^\circ, \cos 1^\circ) \sim (0, \sin 20^\circ, \cos 20^\circ)$. Assume the rotor coordinate system rotate 20 degrees around the Y axis, the stator rotate 10 degrees around X axis, rotate 30 degrees around Y axis, rotate 0 degree around Z axis. The coordinate data are converted to stator coordinate system by using the matrix A_r^s . The converted coordinate and the original coordinate are shown in the same coordinate system. The display result is shown in the Fig 7. The X point in the graph is the point after the transformation of the coordinate system, and the point of the O point is the front of the coordinate transformation. The data points are all on the spherical surface. Accordingly, the 20 sample data will rotate 20 degrees according to the Y axis, and relative to the stator coordinate reverse rotating 10 degrees around the X axis, reverse rotate 30 degrees around Y axis. 20. 20 sample data are presented to show the rotation before and after the rotation of the point.

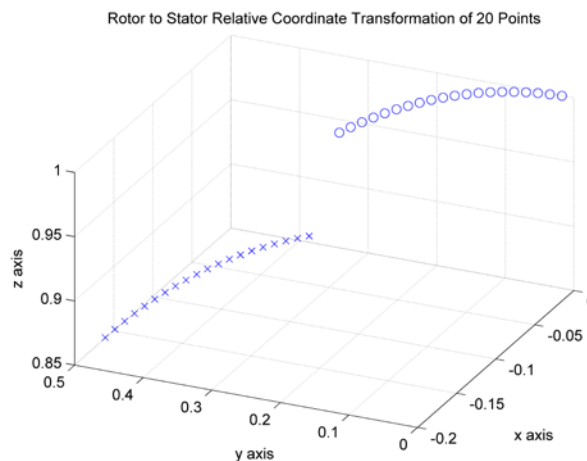

Fig. 7 Rotor-Stator Coordinate Transformation Simulation

3.3.4 The Comparison of Traditional and Relative Coordinate Transformation

The comparison experiment is taken to shown the difference of transformation method. Assuming a point, which coordinate is $(0,0,1)$, on the spherical surface. The coordinate data is calculated in the situation of rotor rotate and the rotor and stator rotate both rotate.

The rotor coordinate system relate to the geodetic coordinate system rotate $1^\circ \sim 20^\circ$ around X axis, rotate 20° around Y axis. The stator coordinate system is not rotated relative to the geodetic coordinate system. The transformed coordinate system is calculated, the data achieved shown in the Table 1.

Table 1: Transformation of Rotor Coordinate System Rotation Situation

1°	2°	3°	4°	5°
(0,-0.0175,0.999 8)	(0,-0.0349,0.999 4)	(0,-0.0523,0.998 6)	(0,-0.0698,0.997 6)	(0,-0.0872,0.996 2)
6°	7°	8°	9°	10°
(0,-0.1045,0.994 5)	(0,-0.1219,0.992 5)	(0,-0.1392,0.990 3)	(0,-0.1564,0.987 7)	(0,-0.1736,0.984 8)
11°	12°	13°	14°	15°
(0,-0.1908,0.981 6)	(0,-0.2079,0.978 1)	(0,-0.2250,0.974 4)	(0,-0.2419,0.970 3)	(0,-0.2588,0.965 9)
16°	17°	18°	19°	20°
(0,-0.2756,0.961 3)	(0,-0.2924,0.956 3)	(0,-0.3090,0.951 1)	(0,-0.3256,0.945 5)	(0,-0.3420,0.939 7)

Relate to the geodetic coordinate system, the rotor coordinate system rotate 20° around Y axis, the stator coordinate system rotate 1°~20° around X axis, rotate 20° around Y axis. The rotor coordinate system data are transformed into stator coordinate system, the transformed data are shown in the Table 2.

Table 2: Transformation of the Stator and Rotor Coordinate System Rotation Situation

1°	2°	3°	4°	5°
(-0.0123,-0.012 3,0.9998)	(-0.0247,-0.024 7,0.9994)	(-0.0370,-0.037 0,0.9986)	(-0.0493,-0.049 3,0.9976)	(-0.0616,-0.061 6,0.9962)
6°	7°	8°	9°	10°
(-0.0739,-0.073 9,0.9945)	(-0.0862,-0.086 2,0.9925)	(-0.0984,-0.098 4,0.9903)	(-0.1106,-0.110 6,0.9877)	(-0.1228,-0.122 8,0.9848)
11°	12°	13°	14°	15°
(-0.1349,-0.134 9,0.9816)	(-0.1470,-0.147 0,0.9781)	(-0.1591,-0.159 1,0.9744)	(-0.1711,-0.171 1,0.9703)	(-0.1830,-0.183 0,0.9659)
16°	17°	18°	19°	20°
(-0.1949,-0.194 9,0.9613)	(-0.2067,-0.206 7,0.9563)	(-0.2185,-0.218 5,0.9511)	(-0.2302,-0.230 2,0.9455)	(-0.2418,-0.241 8,0.9397)

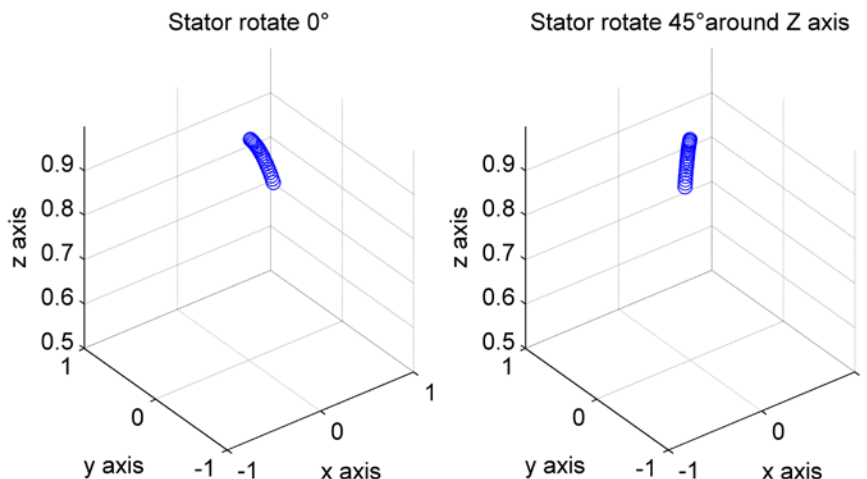

Fig 8 Comparative Simulation Diagram of Relative Coordinate Transformation

It is seen from the figure; the traditional coordinate transformation and rotor-stator coordinate transformation data in different coordinate systems different results. If the stator coordinate system is rotated 45° , using the results of the traditional coordinate transformation is calculated from the stator coordinate system is not rotating coordinate system, that is geodetic coordinate system, which corresponds to the stator coordinate system is rotated 45° incompatible with the actual situation. Traditional coordinate transformation is invalid. The results of relative coordinate transformation shows the original data of the rotor coordinate system is rotated around the Z axis 45° . It matches the actual situation. The relative coordinate transformation is suitable for all kinds of situations. Traditional coordinate transformation can only applied to the stator coordinate system and the geodetic coordinates overlap situation. Relative coordinate transformation is more universal significance.

IV. DESIGN OF DETECTION PLATFORM

4.1 MEMS Six Axis Sensor Attitude Matrix Solution

The attitude matrix solution has been widely used in strapdown inertial navigation system. In the strapdown inertial navigation system, the aircraft generally has a pitch, roll, yaw motion, which is consistent with the three degree of freedom motion of the spherical motor.

Using MEMS six-axis sensor, the space rotation between the carrier coordinate system and navigation coordinate system can be determined. The detected rotation angles are generally used to measure to fill the attitude matrix of the strapdown inertial navigation system. The strapdown inertial navigation system principle diagram is shown in Fig 9.[14-16]

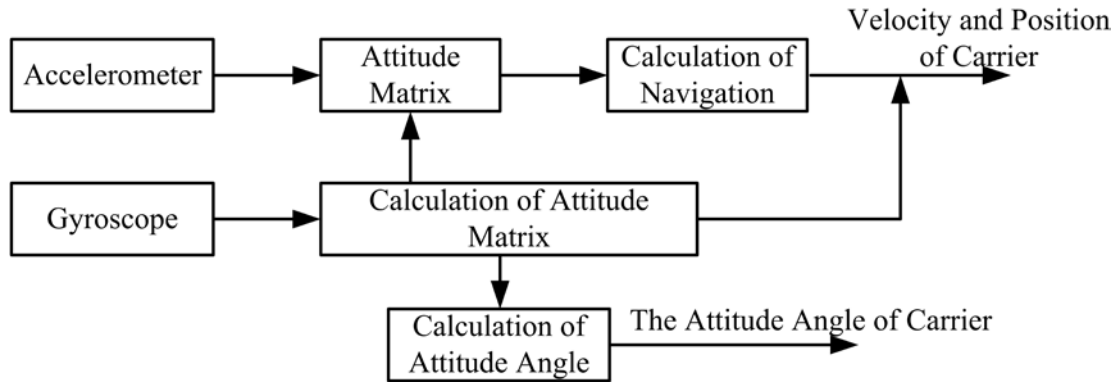

Fig 9. The Strapdown Inertial Navigation System Principle Diagram

The attitude matrix is used to obtain the solution of the spatial attitude, which is obtained from the output of accelerometer and gyro sensor. Attitude solution result is often represented as the pitch angle θ , roll angle ψ , yaw angle γ . The data obtained by MEMS six-axis sensor include acceleration, angular velocity, attitude angle data and the output data of temperature compensation. The data solved in spatial rotation are delivered to host computer. The data transmitted by sensor shown in Fig 10 by using MATLAB platform.

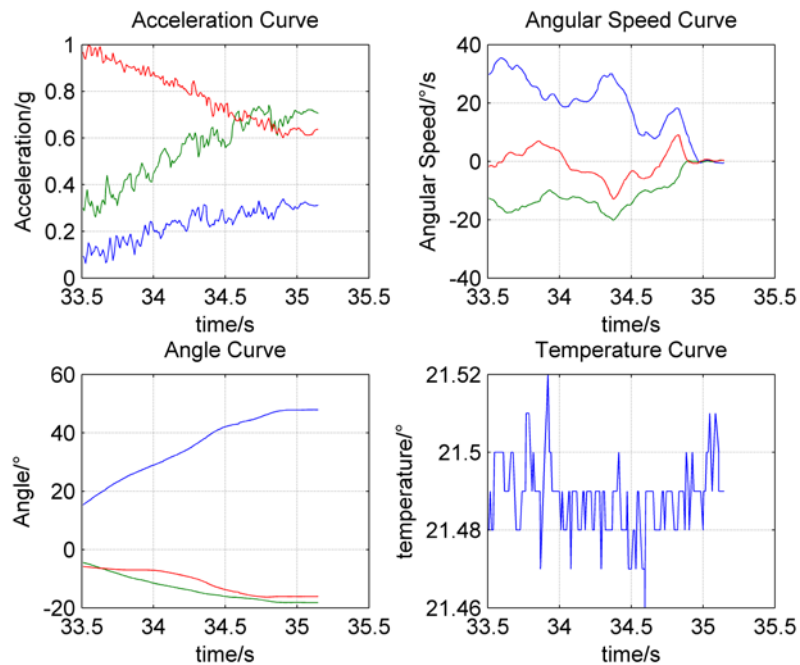

Fig. 10 Six-axis Sensor Data Record Chart

4.2 Relative Position Detection System of Spherical Actuator

The spherical actuator relative position detection system should detect position of rotor coordinate relative to the geodetic reference coordinate system and the position of stator coordinate system relative to the geodetic reference coordinate system. Two six-axis sensors are used to detect both the stator attitude and the rotor attitude. MPU6050 gyroscope is used to detect the attitude in the system. The stator gyroscope is mounted in the stator sphere south, and the rotor gyroscope is mounted in the rotor sphere south. The installation diagram is shown in the Fig 11.

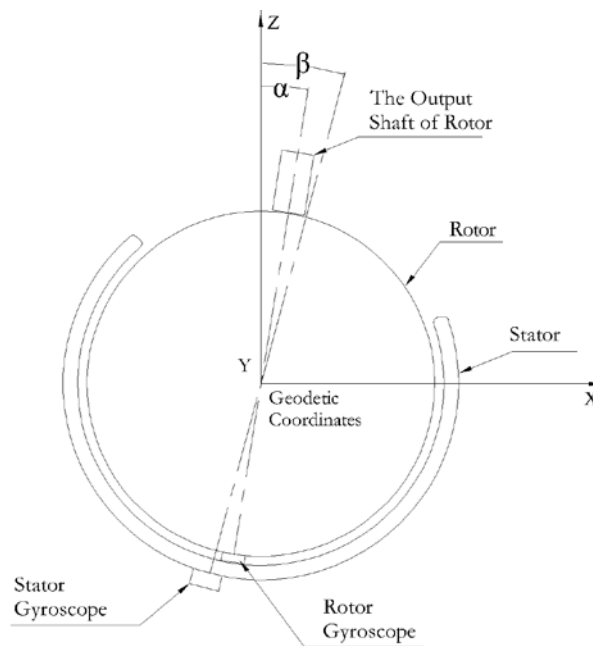

Fig. 11 Relative Position Detection System Installation Diagram of Spherical Actuator

The rotation angles are detected by the gyroscope MPU6050. The output of MPU6050 is solved by attitude solution is three Euler angles, which obey the rotation order x-y-z. Three Euler angles is transmitted to the USB to TTL circuit by serial communication. The master computer using Labview software to access 2 COM ports to obtain stator and rotor attitude solution of the two gyroscopes.

The system hardware block diagram is shown in Fig 12.

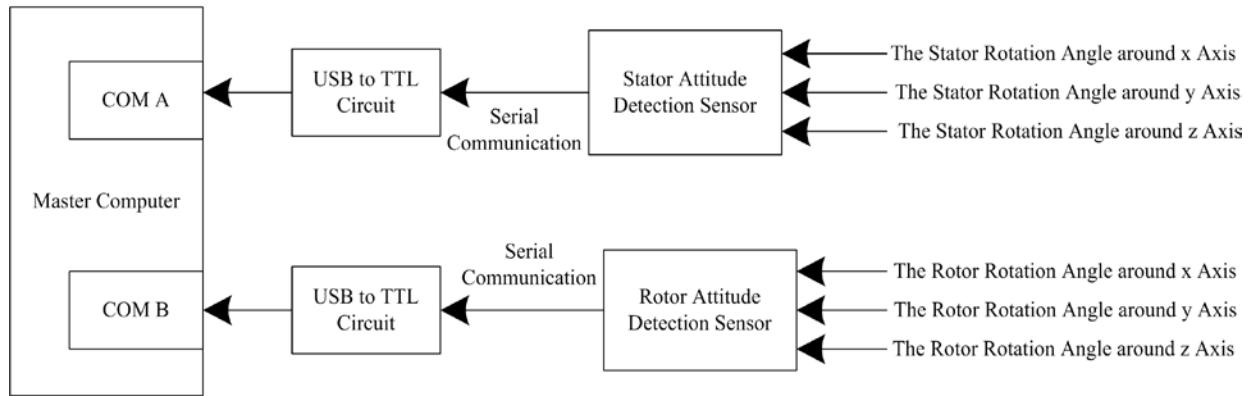

Fig. 12 System Hardware Block Diagram

The master computer software is based on the Labview software in the designed relative position detection system. The direction cosine matrix A_0^r is established by the Euler angles detected by the rotor detection gyroscope. The direction cosine matrix A_0^s is established by the Euler angles detected by the stator detection gyroscope. The Euler angles obeyed the x-y-z rotation order.

The data from stator gyroscope and rotor gyroscope are accessed through COM interface by Labview. According to the communication protocol, the serial communication baud rate is 9600, 1 bit stop bit. The data obtained from sensors are filtered by median filtering method, the data are shown in the chart 1 and chart 2 of Fig 13. In each display interface, the three curves show the rotation angle of the stator and rotor data. Using the MATLAB scripts of Labview, the relative coordinate transformation matrix A_r^s is calculated. When the rotor and stator rotated in the space, the rotor coordinate point (0,0,1) is transformed into stator coordinate system. Three curves in chart 3 show the transformed data. The system flow chart is shown in the Fig 14.

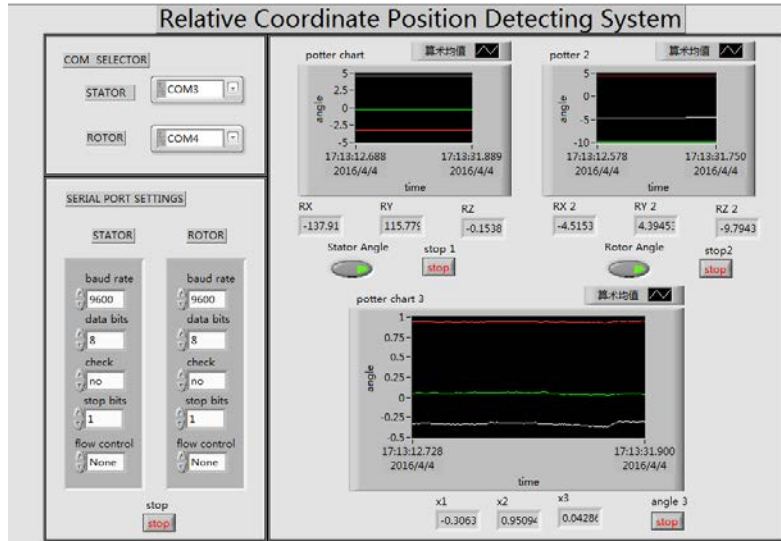

Fig. 13 Master Computer Panel

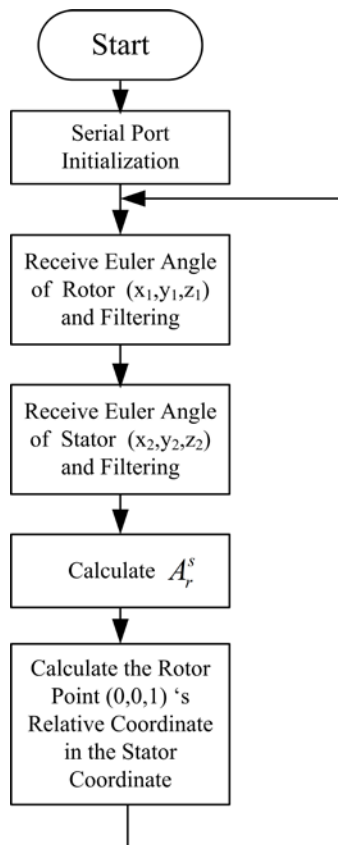

Fig. 14 Master Computer Software Flow Chart

The physical picture of the entire design platform is shown in Fig 15. The annotation in graphs is shown in Table 3.

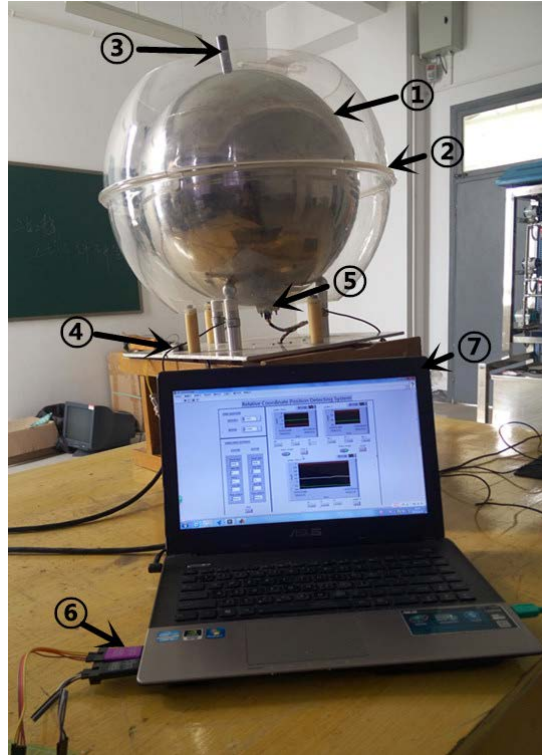

Fig. 15 Physical Relative Position Detection Platform

Table 3. Spherical Actuator Relative Position Detection System

Number	Name
①	Rotor
②	Stator
③	Output Shaft
④	Stator Sensor
⑤	Rotor Sensor
⑥	USB to TTL Circuit
⑦	Host Computer

V. SENSOR DATA TRANSFORMATION

When the rotor rotates, the rotation angle of the sensor is read continuously by the rotor attitude detection sensor. The point (1,0,0) in the rotor coordinate, in different situation of stator rotates 0° around Y axis, stator rotates 15° around Y axis, stator rotates 30° around Y axis, stator rotates 45° around Y axis. The locus of the point is show in the Fig 16 annotated in \times .

Obviously, due to the rotor rotation movement, the point data transformed in the rotor coordinate system is shown as a series of trace. That is, the point is rotated equivalent. Whatever the stator attitude change, the trajectory shape of the four sub graphs should be consistent. The simulation result shows the characteristic. According to the sub graph 1-4, the sub graph 2 to 4 is equivalent to the 1 sub graph on the original basis around the Y axis once again rotated 15 degrees, 30 degrees and 45 degrees.

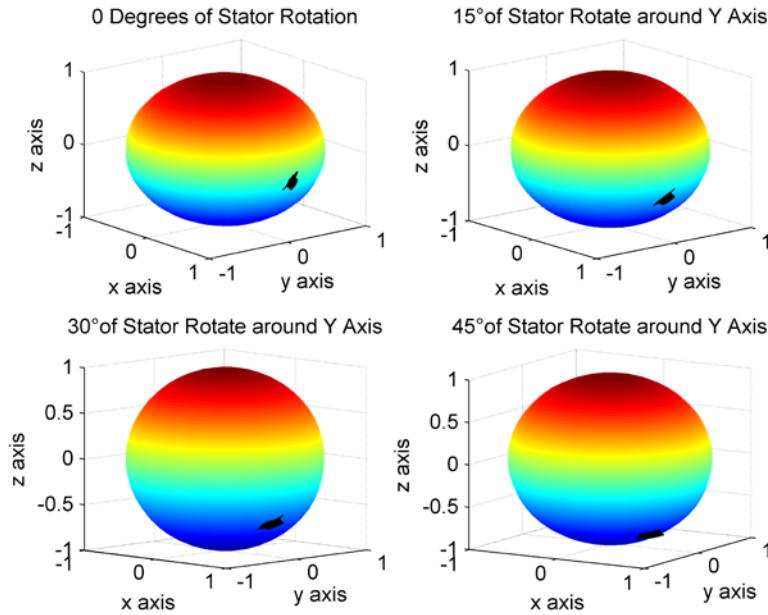

Fig 16 Simulation Result of Rotor Sensor Data

VI. PHYSICAL SIGNIFICANCE OF RELATIVE TRANSFORMATION MATRIX

In the field of spherical actuator, the stator coordinate system R_s is considered as the geodetic coordinate system R_0 . The particularity of the spherical motor makes it necessary to obtain the relative position of the stator and rotor. In the situation of stator doesn't move, the stator coordinate system R_s is equivalent to the geodetic coordinate system R_0 , as a special case.

When using Lorentz force to control the spherical actuator, the relative position between the coil of the stator and the permanent magnet should be obtained. Through detecting the rotation angles the stator coordinate system R_s relative to the geodetic coordinate system R_0 , the direction cosine matrix A_0^s can be obtained. A_0^r can be obtained in the same method.

Then, the relative transformation matrix A_s^r is acquired. Generally extended to three degrees of freedom of the motor Lorentz force vector, magnetic vector, stator and rotor coordinates can complete the stator to rotor and rotor to the stator coordinate transformation.

VII. CONCLUSION

Through the analysis of the simulation result, the traditional absolute position detection method of spherical actuator is improved. The traditional coordinate transformation is set as a special case of the relative coordinate transformation. Using the relative coordinate transformation also can solve the traditional coordinate transformation. The actuator can be performed any attitude in space, i.e., applied to the joints of the robot arm. Setting both rotor and stator MEMS six-axis sensors, the stator and the rotor attitude can be detected. The relative position detection can be achieved by using the relative coordinate transformation. The relative coordinate transformation has physical meaning. Relative coordinate transformation applies for 3 DOF spherical actuator and is more scientific and universal.

ACKNOWLEDGMENT

This work is partially supported by Provincial Natural Science Research Project of Anhui Province (KJ2014A173) and Supported by the Open Research Fund of Anhui Key Laboratory of Electric Drive and Control, AnHui Polytechnic University.

The authors also gratefully acknowledge the helpful comments and suggestions of the reviewers, which have improved the presentation.

REFERENCES

- [1]Leopoldo Rossini;Emmanuel Onillon;Olivier Chételat, “Closed-loop magnetic bearing and angular velocity control of a reaction sphere actuator”, *Mechatronics*, Vo. 30, 2015, pp. 214-224.
- [2]Liang Yan, Zewu Wu, Zongxia Jiao, “Equivalent energized coil model for magnetic field of permanent-magnet spherical actuators”, *Sensors and Actuators A: Physical*, 2015, 229,68-76;
- [3]Z. Li, Q. Lun, D. Xing, and P. Gao, “Analysis and Implementation of a 3-DOF Deflection-Type PM Motor”, *IEEE TRANSACTIONS ON MAGNETICS*.VOL. 51, NOVEMBER 2015
- [4].MASAHITO TSUKANO, KATSUHIRO HIRATA, SHUHEI MAEDA, “Development of Control Method for Outer-Rotor Spherical Actuator”, *Electrical Engineering in Japan*, Vol.194,

No.2, 2016, pp.54-63.

[5]Wang Qunjing, Qian Zhe, Li Guoli, “Vision based orientation detection method and control of a spherical motor”, Midwest Symposium on Circuits and Systems Conference Proceedings, pp.1145-1148, 2010.

[6]Lee K. M. and Kwan C. K., “Design concept development of a spherical stepper for robotics applications”, In IEEE Transactions on Robotics and Automation, vol. 7, No.1, pp.175-181, February 1991.

[7]Yan L., “Modeling and Design of a three degree-of-freedom Permanent Magnet Spherical Actuator”, PhD thesis, School of Mechanical & Aerospace Engineering, Nanyang Technological University, Singapore, 2007.

[8]. Ma Yu, “Intelligent Neural Network Control Strategy of Hydraulic System Driven by Servo Motor”, International Journal on Smart Sensing and Intelligent Systems, VOL.8, NO. 2, pp1406-1423, JUNE 2015.

[9].Takehito Azuma, “A Method to Design PID Controllers Using FRIT-PSO”, International Journal on Smart Sensing and Intelligent Systems, VOL. 8, NO.4, pp.1876-1895, DECEMBER 2015.

[10]WANG Qun-jing, CHEN Li-xia, LI Zheng, “The Control of a Permanent Magnet Spherical Stepper Motor Based on the Coder of Optoelectronic Sensors”, Proceedings of the CSEE.Vol.25 No.7 July 2005.

[11]WANG Qun-jing, QIAN Zhe, LI Zheng, “Method of Measuring the Rotor Position of Permanent Magnetic Spherical Stepper Motor Based on Machine Vision”, Proceedings of the CSEE.Vol.28 No.36 Dec.25, 2008.

[12].Weihai Chen,Liang Zhang,Liang Yan, “Design and control of a three degree-of-freedom permanent magnet spherical actuator”, Sensors and Actuators A: Physical, Vol.180, 2012, pp.75-86.

[13].Liang Yan, I-Ming Chen, Zhongwei Guo, “A Multi-degree-of-freedom Orientation Measurement Methodology with Laser Detection”, 2009 IEEE/ASME International Conference on Advanced Intelligent Mechatronics, Singapore, July 14-17, 2009.

[14].Zhang Rong-hui ,Jia Hong-guang,Chen Tao, “Attitude solution for strapdown inertial navigation system based on quaternion algorithm”, Optics and Precision Engineering, Vol.16,

No.10. Oct.2008.

[15] Lee K, Kwan C K, “Design concept development of a spherical stepper for robotic applications”, IEEE Transactions on Robotics and Automation, Vol.7, No.1, 1991, pp. 175-180.

[16].LI Long,HOU Jian-wen, SHI Xiao-ping, “Adaptive sliding mode control for spacecraft attitude tracking system”, Electric Machines and Control, Vol.19 No.12, Feb 2015.